

# ES

## Cement Screw Conveyors & Feeders

*Zementschnecken*

*Transporteurs à vis à ciment*

*Coclee per cemento*



WAM® has become the world's leader in supplying Cement Screw Conveyors and Feeders due to uncompromising dedication to research in powder handling technology, as well as constant improvement of product and manufacturing technology.

In the past forty years the ES Screw Conveyor has become synonymous with cement feeding and conveying in concrete plants all over the world. During this period WAM® have supplied more than two hundred thousand units worldwide. At the beginning of the new millennium it would be difficult to find a concrete plant operator anywhere in the world who does not appreciate the unrivalled technical features and quality of the ES.

Die Erfolgsgeschichte der ES-Zementschnecke beruht auf kontinuierlicher praxisorientierter Forschung und Entwicklung im Bereich der Schüttguttechnik und einer ständigen Verbesserung von Produkt und Produktionsmitteln.

In den letzten 40 Jahren wurde die ES-Schnecke zum Synonym für Zementförderung und -dosierung in Betonaufbereitungsanlagen in aller Welt. In diesem Zeitraum hat WAM® mehr als 200.000 ES-Schnecken in alle Erdteile geliefert. Zu Beginn des dritten Jahrtausends findet sich weltweit wohl kaum ein Betonhersteller, der die hervorragenden technischen Eigenschaften und die unerreichte Qualität der ES-Schnecke nicht zu schätzen wüßte.

WAM® est devenu leader mondial dans la fourniture de transporteurs à vis à ciment grâce à la recherche et au développement constants dans le domaine de la manutention des matériaux en vrac et à l'amélioration continue du produit et de la technologie de fabrication.

Durant les 40 dernières années, la vis ES est devenue synonyme de transport et dosage du ciment dans les centrales à béton dans le monde entier. Durant cette période WAM® a fourni plus que 200.000 vis ES sur chaque continent. Au début du 3<sup>ème</sup> millénaire il serait difficile de trouver un producteur de béton dans n'importe coin du monde qui n'apprécierait pas les caractéristiques techniques extraordinaires et la qualité incomparable de la vis ES.

WAM® ha raggiunto la leadership mondiale nella fornitura di trasportatori a coclea per cemento grazie alla continua ricerca e lo sviluppo nell'ambito del trattamento dei materiali in polvere e al costante miglioramento del prodotto e delle tecnologie di produzione.

Negli ultimi 40 anni la coclea ES è diventata sinonimo di estrazione e convogliamento del cemento negli impianti di betonaggio in tutto il mondo. Durante questo periodo WAM® ha fornito più di 200.000 coclee ES in ogni continente. All'inizio del 3<sup>o</sup> millennio sarebbe difficile trovare un produttore di calcestruzzo in qualsiasi parte del mondo che non sappia apprezzare le straordinarie caratteristiche tecniche nonché la qualità imparagonabile della coclea ES.

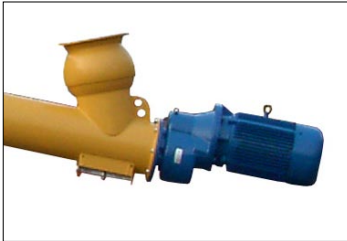

**Universal Inlet Spouts**

Universaleinläufe  
Bouches d'entrée universelles  
Bocche di carico universali



**Splined Shaft Design**

Evolventenkeilwellenverbindung  
Arbre cannelé  
Albero calettato

**Lifting Lug**

Kranöse  
Oeillet  
Golfaro



**Electric Motor**

Elektromotor  
Moteur électrique  
Motore elettrico

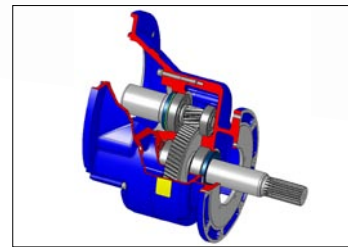

**Gear Reduction Unit:**

- Heavy-Duty Design
- Oversized Gears

**Getriebe:**

- Robuste Konstruktion
- Überdimensionierte Zahnräder

**Réducteur:**

- Construction pour service lourd
- Engrenages sùrdimensionnés

**Riduttore:**

- Costruzione per servizio pesante
- Ingranaggi sovradimensionati

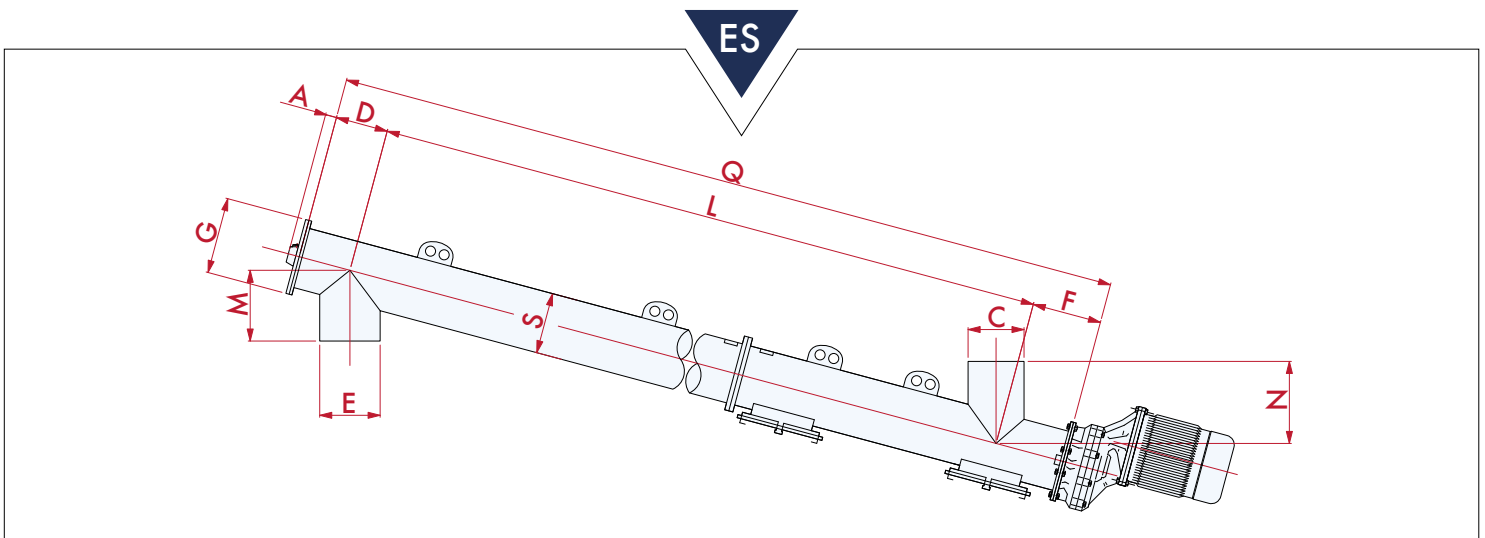

- Intermediate Bearing:**
- Engineered for Minimum Product Obstruction
  - Low Maintenance
  - Perfect Alignment

- Zwischenlager:**
- Geringstmögliche Behinderung des Materialflusses
  - Geringer Wartungsaufwand
  - Perfekte Zentrierung

- Palier intermédiaire:**
- Construit pour offrir obstruction minimum
  - Maintenance minimum
  - Alignement optimal

- Supporto intermedio:**
- Costruito per offrire ostruzione minima
  - Manutenzione minima
  - Allineamento ottimale



- Outlet end Bearing with Splined Shaft Coupling:**
- Quick Installation
  - Low Maintenance

- Auslauflager mit Evolventenkeilwellenverbindung:**
- Schneller Einbau
  - Geringer Wartungsaufwand

- Support palier de sortie:**
- Installation rapide
  - Maintenance minimum

- Testata di scarico con accoppiamento calettato:**
- Installazione veloce
  - Minima manutenzione

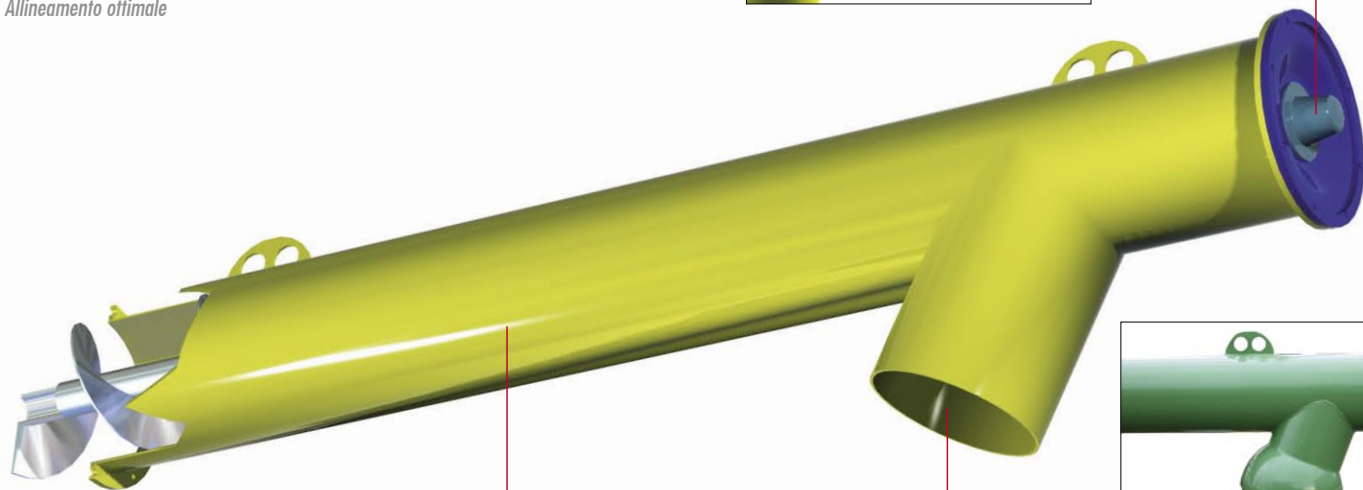
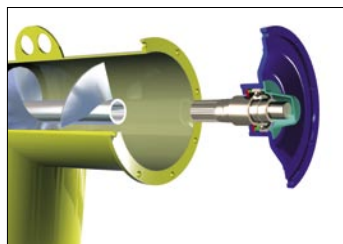

- Standard Inspection Hatch**
- Inspektionsklappe serienmäßig*
- Trappe de visite standard*
- Boccaporto di ispezione standard*

- Shot-Blasting and Powder-Coating Finish**
- Finish: Stahlstrahlen und Pulverbeschichtung*
- Sablage et peinture à poudre*
- Granigliatura e verniciatura a polvere*

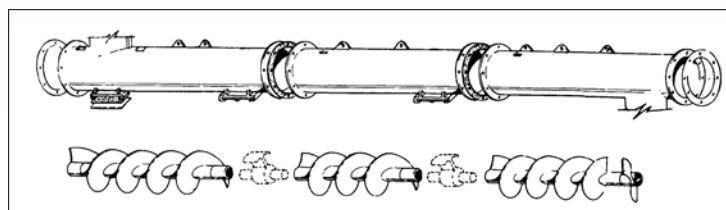
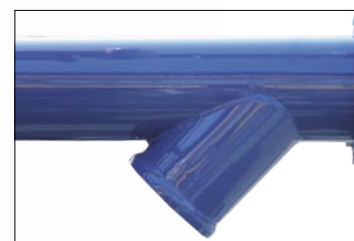

- Modular Design:**
- Ease of Shipping
  - Ease of On-Site Assembly

- Modulbauweise:**
- Transportfreundlich
  - Einfache Vor-Ort-Montage

- Construction modulaire:**
- Facile à transporter
  - Facile à monter sur chantier

- Costruzione modulare:**
- Facile a trasportare
  - Facile a montare in cantiere

Ø S	114	139	168	193	219	273	323
A	56	56	40	40	40	40	40
C	on request nach Wunsch						
D	120	120	140	150	160	180	220
E	on request nach Wunsch						
F	140	140	160	170	180	220	220
L	on request nach Wunsch						
G	190	190	250	250	275	330	405
M	on request nach Wunsch						
N	see WAM - standard siehe WAM - Norm						
Q	L + D + E						

Dimensions in mm

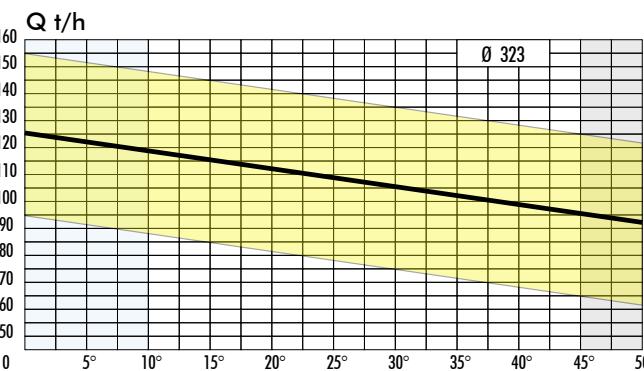
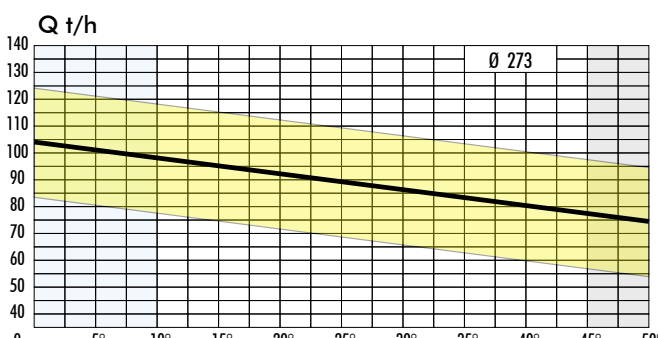
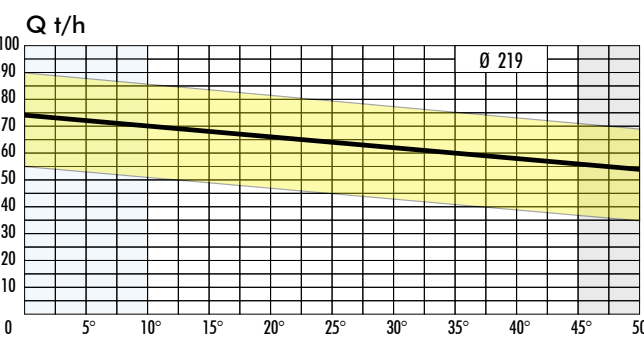
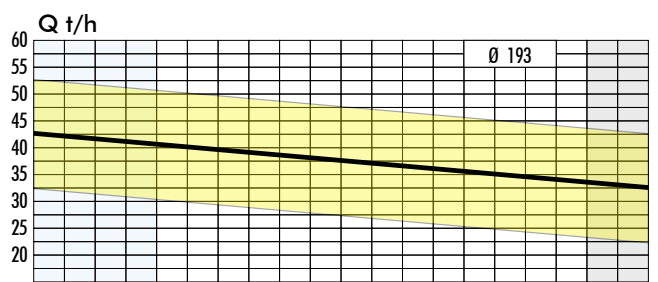
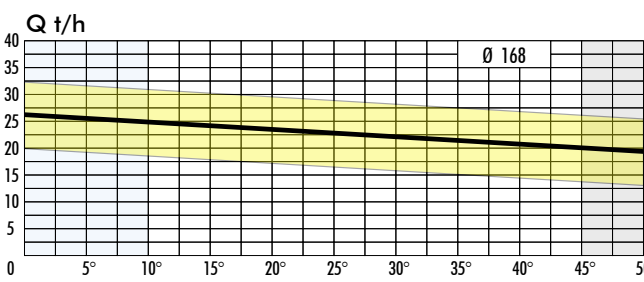
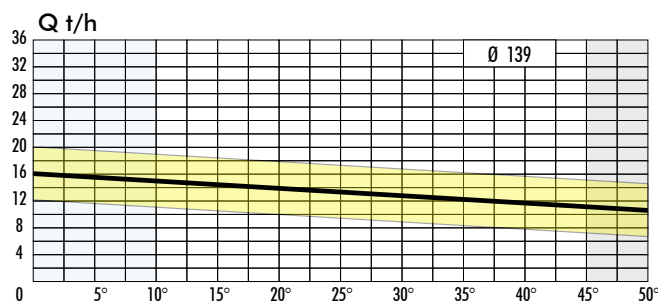
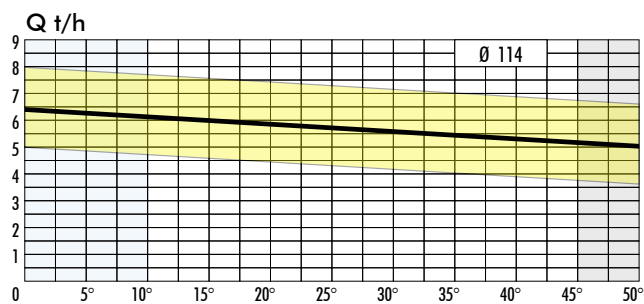

**THROUGHPUT RATES**

Throughput rates are valid only if the silo design and silo cone fluidisation are carried out correctly.

Throughput rates are based on Portland cement having a bulk density of 1.13 t/m<sup>3</sup>. To obtain the above throughput rates a constant and even material flow from the silo is required.

\*  Theoretical throughput rate

\* Theoretische Durchsatzleistung

\* Ligne débit théorique

\* Linea portata teorica

**DURCHSATZLEISTUNGEN**

Die Leistungsangaben gelten für fachmännische Silokonstruktionen und eine fachgerecht ausgeführte, einwandfrei funktionierende Luftauflockerungsanlage im Silokonus

Die Tabellenangaben beziehen sich auf Portland-Zement mit einem Schüttgewicht von 1,13 t/m<sup>3</sup>. Zum Erzielen der o. a. Durchsatzleistungen ist ein gleichförmiger Materialfluss aus dem Silokonus unabdingbar.

 Throughput rate depending on bulk density of cement

Durchsatzleistung abhängig vom Zement-Schüttgewicht

Champs où varie le débit en fonction du poids spécifique du ciment

Campo in cui varia la portata in funzione del peso specifico del cemento

**DIAGRAMME DES DEBITS**

Les débits indiqués se rapportent à une construction correcte du silo et à une bonne fluidification du cône.

Les débits sont obtenus avec du ciment Portland, poids spécifique 1,13 t/m<sup>3</sup>. Pour obtenir les débits indiqués, il est indispensable de garantir un écoulement constant du ciment du silo.

 Throughput rate not in proportion

Durchsatzleistungskurve nicht proportional

Zone dans laquelle certains types de ciment se comportent de manière non proportionnelle

Zona in cui certi cementi si comportano in modo non proporzionale

**DIAGRAMMA DELLE PORTATE**

Le portate sono riferite a coclee che estraggono da silo costruiti e fluidificati in modo corretto

Le portate si riferiscono a cemento Portland con peso specifico di 1,13 t/m<sup>3</sup>. Per ottenere le portate indicate qui sopra è indispensabile una discesa costante del cemento nel silo e uno scarico omogeneo del cono del silo.

 Possible flushing of the cement

Mögliches Durchschießen des Zements

Zona où le siphonnage total ou partiel est possible

Zona di possibile sifonaggio totale o parziale







WAM S.p.A.  
Via Cavour, 338  
I - 41030 Ponte Motta  
Cavezzo (MO) - ITALY

Tel: +39 / 0535 / 61 81 11  
Fax: +39 / 0535 / 61 82 26

info@wamgroup.com  
www.wamgroup.com

Further Products - Weitere Produkte - Autre production - Altra produzione

