

## VB - Vibrating Bin Selection Chart

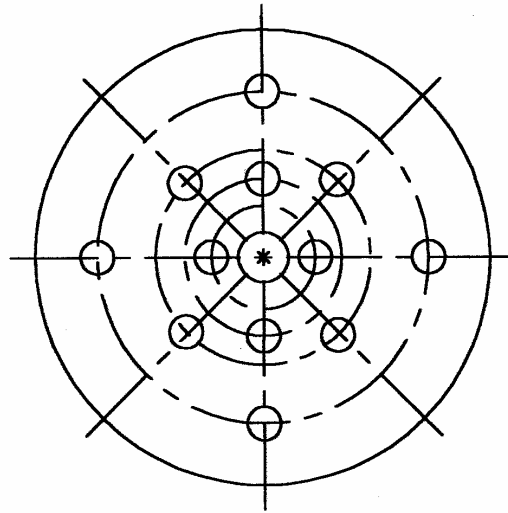

N.12 VB

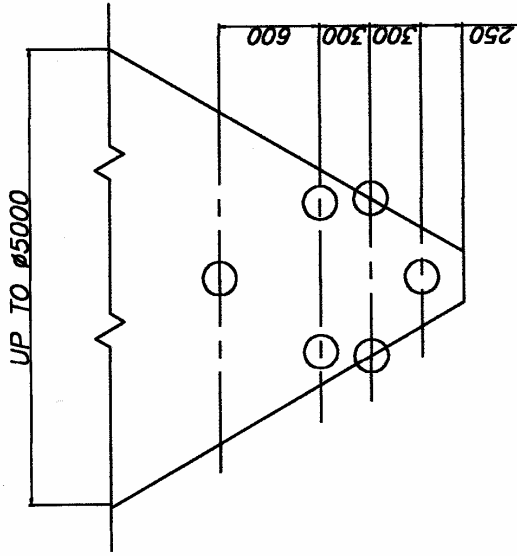
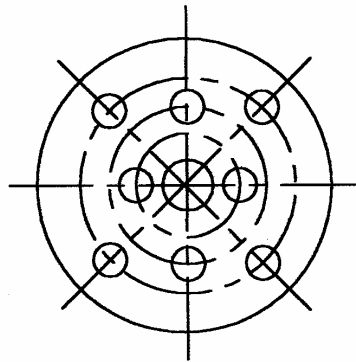
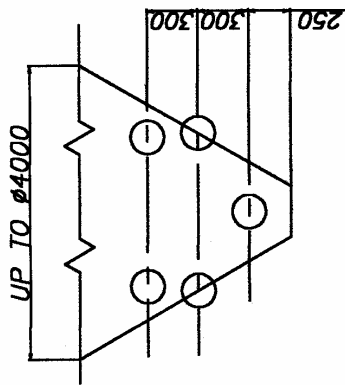

N.8 VB

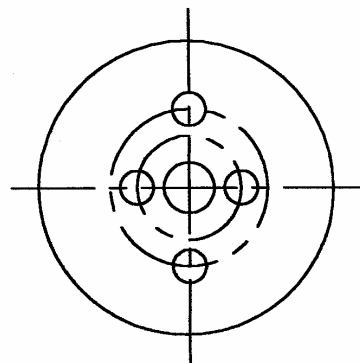
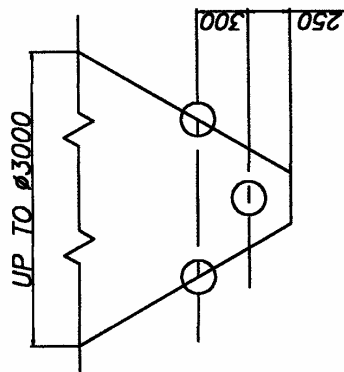

N.4 VB

# I 100 – Fluidisation Pads Selection Chart

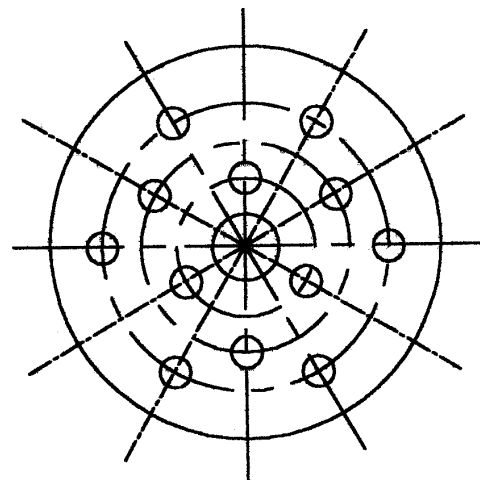
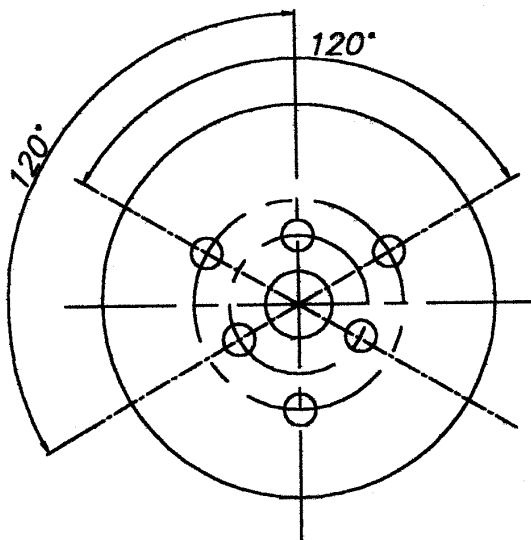
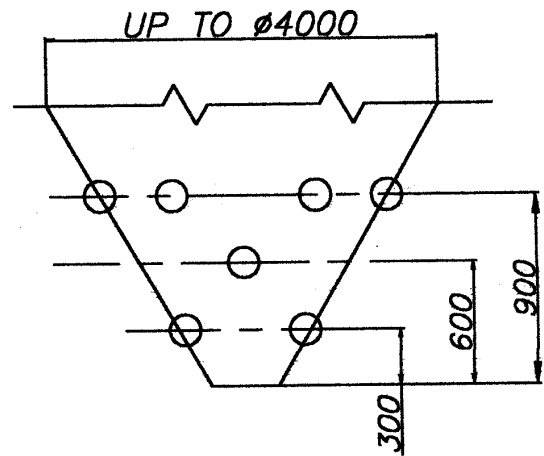
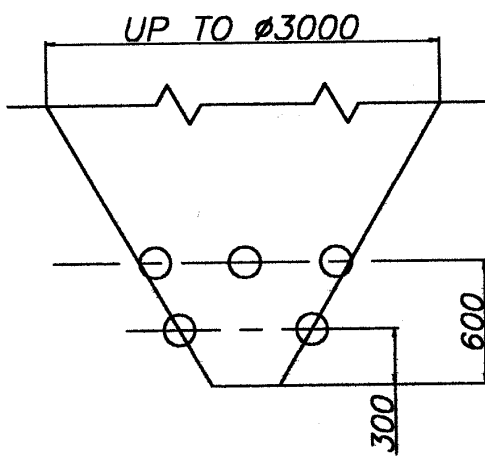

N.6 1100

N.12 1100

## U 025 – Fluidisation Nozzles Selection Chart

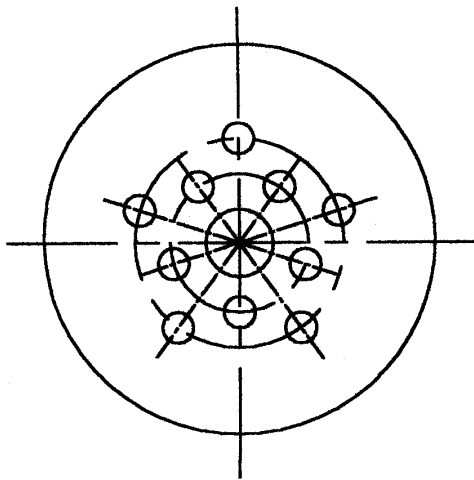
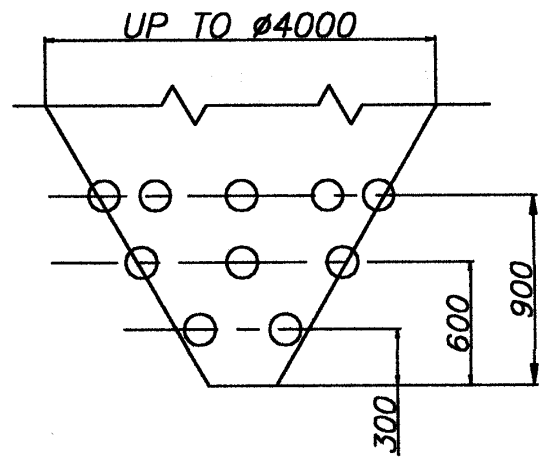
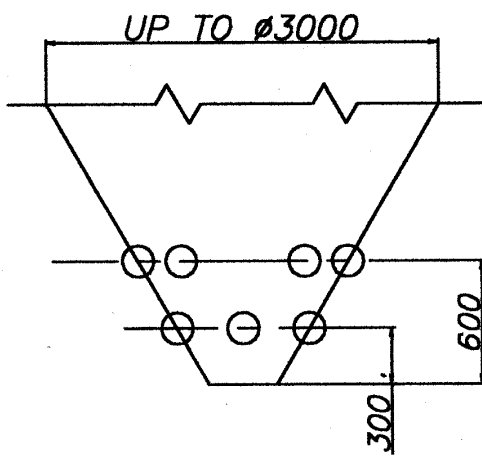

N.10 U025

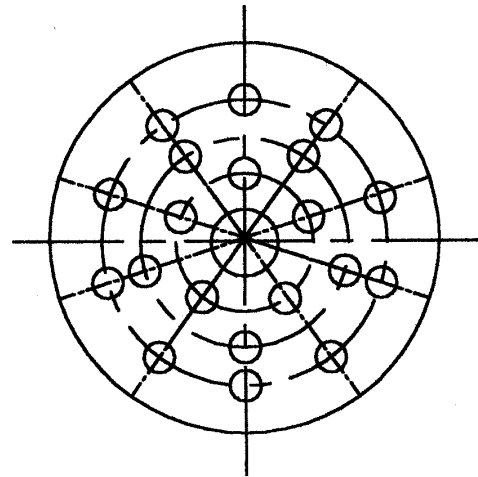

N.20 U025